

USA[®]
A.Ş.

Unique Solutions at Applications

an EPC company

US||A

Unique Solutions at Applications

FABRİKA OTOMASYON VE MÜHENDİSLİK TİC. A.Ş.

an EPC company

“Endüstrinin Mimarı”



❖ MÜHENDİSLİK ve PROJE HİZMETLERİ

- ✓ PROSES
- ✓ MEKANİK ve BORULAMA
- ✓ ELEKTRİK
- ✓ ENSTRÜMANTASYON
- ✓ OTOMASYON

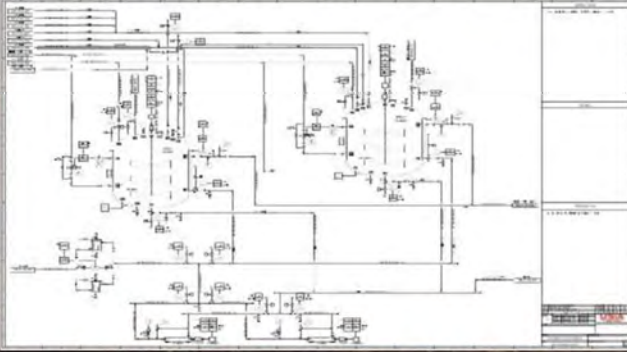

❖ MONTAJ HİZMETLERİ

- ✓ MEKANİK ve BORULAMA
- ✓ ELEKTRİK
- ✓ ENSTRÜMANTASYON
- ✓ OTOMASYON



❖ TEDARİK

- ✓ PROSES EKİPMAN ve SİSTEMLERİ
- ✓ MEKANİK ve BORULAMA İMALATLARI
- ✓ ELEKTRİK
- ✓ ÖLÇÜM ve KONTROL CİHAZLARI
- ✓ OTOMASYON KONTROL SİSTEMLERİ



Misyon & Vizyon



Misyonumuz;

Sahip olduğumuz tüm bilgi, beceri ve tecrübeyi kullanarak, çözüm ortaklarımız ile birlikte, müşterilerimize kaliteli ve ihtiyaçlarına uygun çözümleri sunmak, girişimci ruhumuz ve sürekli öğrenme ve öğretme politikamızla, tüm paydaşlarımızla beraber sürekli gelişim ve birlikte öğrenmeyi esas alan, yasal mevzuatlar, iş güvenliği, çevre ve geleceği düşünen verimlilik esaslı çözümlerle teknolojiyi yakından takip eden projeler geliştirmek.

Vizyonumuz;

Yıllar boyu edindiğimiz entelektüel sermayemiz olan teknik bilgi, beceri ve tecrübeyi, çözüm ortağımız olan firmalar ile birlikte, müşterilerimizin aradıkları özel ve genel her türlü ihtiyaçlarını tam karşılayan hizmet anlayışı ile problemleri mühendisliğin gerektirdiği en uygun çözümleri kullanarak, özellikle anahtar teslimli projelerde; Türkiye ve hedef ülkelerde aranan ve ilk akla gelen, uygulayıcı bir mühendislik firması olmak.



Hizmet Verdiğimiz Sektörler

Kimya ve Petrokimya



Gıda ve Bioteknoloji



Maden ve Mineral



Yenilenebilir Enerji



İlaç Sanayi



Savunma Sanayi



Faaliyet Alanlarımız



- ✓ PROSES
- ✓ MEKANİK
- ✓ BORULAMA
- ✓ ELEKTRİK
- ✓ ENSTRÜMANTASYON
- ✓ OTOMASYON



Proses



Mühendislik

- ✓ Fizibilite Analizleri
- ✓ Proses Akış Şemaları
- ✓ Kütle ve Enerji Derinlikleri
- ✓ Simülasyon ve Modelleme
- ✓ Borulama ve Enstrümantasyon Şemaları (P&ID)
- ✓ Ekipman Tasarımı ve Bilgi Föyleri
- ✓ Yardımcı Tesis Kapasite ve Özellikleri Tayini
- ✓ HazOp ve Proses Güvenliği Hizmetleri (Atex)

Proje

- ✓ Temel ve Ön Mühendislik
- ✓ Tasarım ve Projelendirme
- ✓ Fabrika ve Saha İmalat Kabul Testleri
- ✓ Montaj Süpervizörlüğü
- ✓ Saha Testleri
- ✓ Devreye Alma
- ✓ Danışmanlık

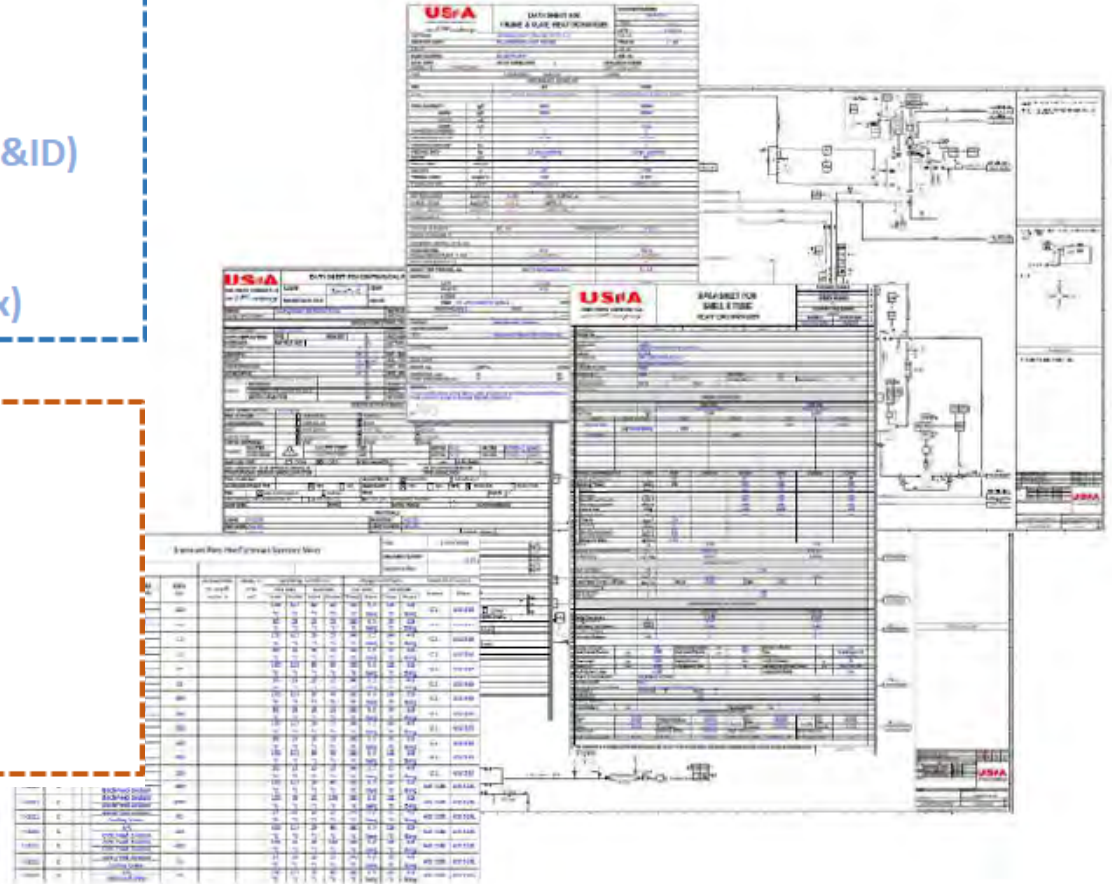

Mekanik ve Borulama



Mühendislik

- ✓ Proses Ekipmanı Mekanik Tasarımı
- ✓ Fabrika – Proses Ekipman Yerleşimi
- ✓ Borulama 3D Yerleşimleri
- ✓ Boru Stres Analizleri

Proje

- ✓ Ekipman İmalatı ve/veya Sevkiyatı
- ✓ Fabrika ve Saha İmalat Kabul Testleri
- ✓ Ekipman Montajı ve Süpervizörlüğü
- ✓ Boru İmalat ve Montajı
- ✓ Saha Testleri
- ✓ Kabul ve Devreye Alma Hizmetleri

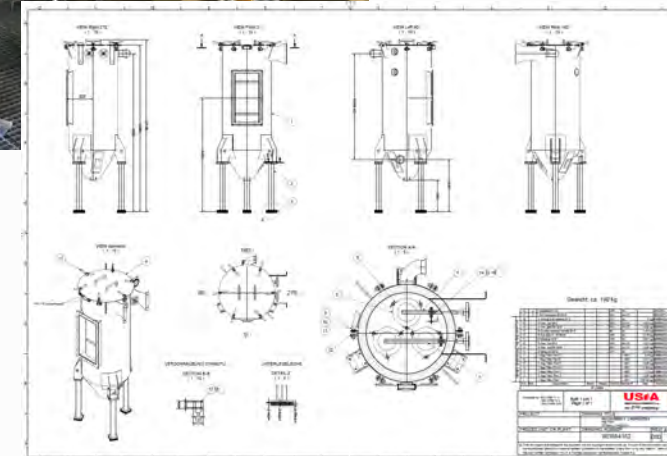
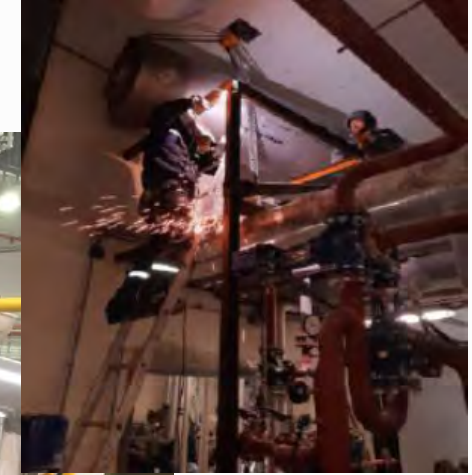
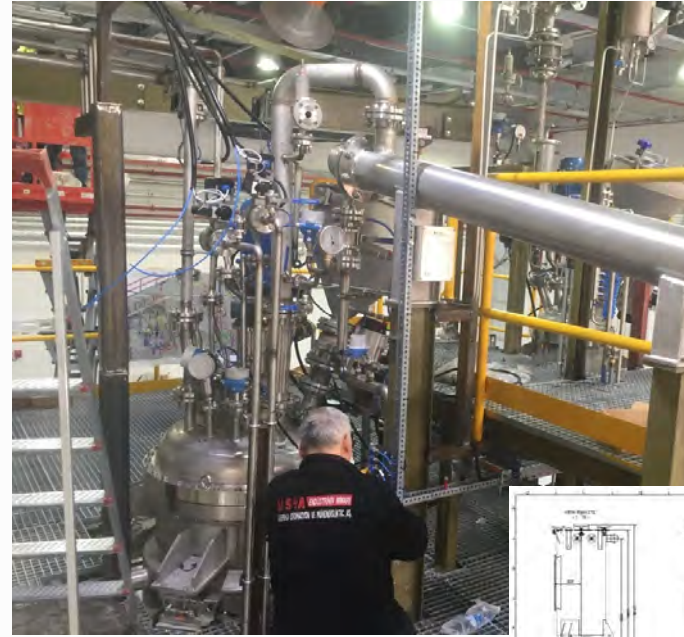

Otomasyon



Mühendislik

- ✓ Kesik – Sürekli – Sıralı Proses Kontrol Sistemleri
- ✓ Reçete Otomasyon Sistemleri
- ✓ Yazılım ve Programlama
- ✓ SIF – SIS Tasarımı, SIL Hesapları ve Cihaz Seçimi
- ✓ Proses Emniyet (ESD) Konsepti Kontrol Sistemleri
- ✓ Pnömatik Sistemler
- ✓ Hidrolik Sistemler
- ✓ Endüstri 4.0 Uygulamaları
- ✓ Karanlık Fabrika Uygulamaları

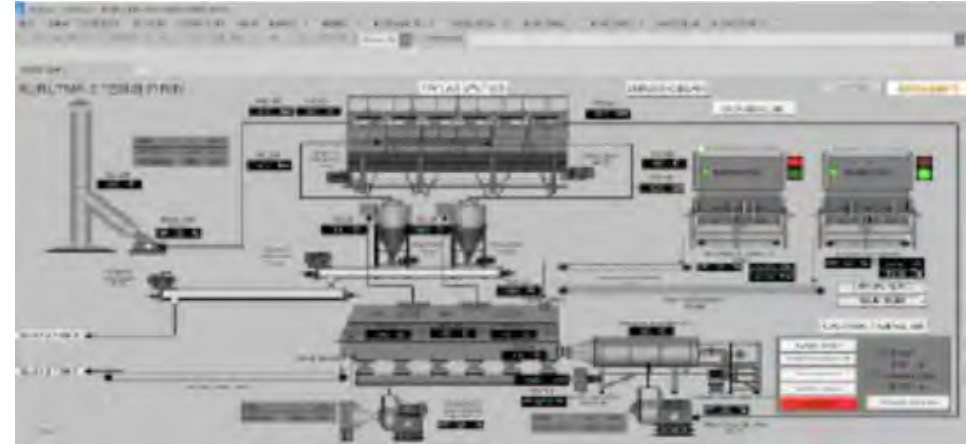

Proje

- ✓ Temel ve Detay Mühendislik Çalışmaları
- ✓ Tasarım ve Projelendirme Hizmetleri
- ✓ Ürün – Cihaz - Sistem Satış ve Tedariği
- ✓ Yazılım ve Donanım
- ✓ I/O Testleri
- ✓ Montaj ve Süpervizörlüğü
- ✓ Kabul ve Devreye Alma Hizmetleri
- ✓ Bakım – Tutum Hizmetleri
- ✓ Danışmanlık

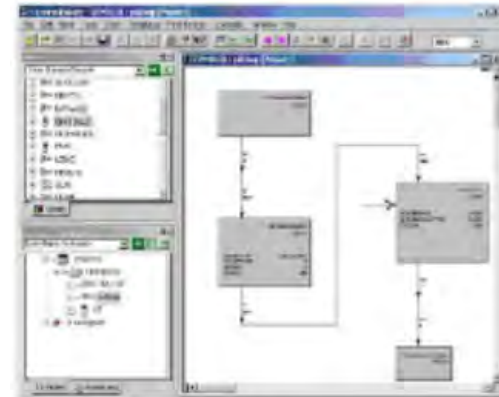

US A		MÜHÜR	
MÜHÜR		MÜHÜR	
NO	REVİZYON	NO	REVİZYON
1	1	1	1
2	2	2	2
3	3	3	3
4	4	4	4
5	5	5	5
6	6	6	6
7	7	7	7
8	8	8	8
9	9	9	9
10	10	10	10
11	11	11	11
12	12	12	12
13	13	13	13
14	14	14	14
15	15	15	15
16	16	16	16
17	17	17	17
18	18	18	18
19	19	19	19
20	20	20	20
21	21	21	21
22	22	22	22
23	23	23	23
24	24	24	24
25	25	25	25
26	26	26	26
27	27	27	27
28	28	28	28
29	29	29	29
30	30	30	30
31	31	31	31
32	32	32	32
33	33	33	33
34	34	34	34
35	35	35	35
36	36	36	36
37	37	37	37
38	38	38	38
39	39	39	39
40	40	40	40
41	41	41	41
42	42	42	42
43	43	43	43
44	44	44	44
45	45	45	45
46	46	46	46
47	47	47	47
48	48	48	48
49	49	49	49
50	50	50	50
51	51	51	51
52	52	52	52
53	53	53	53
54	54	54	54
55	55	55	55
56	56	56	56
57	57	57	57
58	58	58	58
59	59	59	59
60	60	60	60
61	61	61	61
62	62	62	62
63	63	63	63
64	64	64	64
65	65	65	65
66	66	66	66
67	67	67	67
68	68	68	68
69	69	69	69
70	70	70	70
71	71	71	71
72	72	72	72
73	73	73	73
74	74	74	74
75	75	75	75
76	76	76	76
77	77	77	77
78	78	78	78
79	79	79	79
80	80	80	80
81	81	81	81
82	82	82	82
83	83	83	83
84	84	84	84
85	85	85	85
86	86	86	86
87	87	87	87
88	88	88	88
89	89	89	89
90	90	90	90
91	91	91	91
92	92	92	92
93	93	93	93
94	94	94	94
95	95	95	95
96	96	96	96
97	97	97	97
98	98	98	98
99	99	99	99
100	100	100	100

Güçlü Yönlerimiz



- ✓ **Proje Yönetimi ve Disiplini**
- ✓ **Entelektüel Sermaye**
- ✓ **Endüstri Tecrübesi**
- ✓ **Karşılıklı Güven**
- ✓ **Müşteri İhtiyaçlarına Optimum Çözümler**
- ✓ **İletişim**

Sistem Entegratörlüklerimiz



Honeywell

Schneider
Electric

FESTO

Referanslarımız



Mercedes-Benz



İmalatlarımız



-SİRKÜLATÖRLER

-SCRUBER SİSTEMLERİ

-SIVI ve TOZ TRANSFER SİSTEMLERİ

-OTOMATİK DOLUM SİSTEMLERİ

US||A

Unique Solutions at Applications

an EPC company

US||A
FABRİKA OTOMASYON VE MÜHENDİSLİK TİC. A.Ş.
an EPC company

HCUSA
MADE IN TURKEY
US A Fabrika Otomasyon ve Mühendislik Ticaret A.Ş.
Çarşıbaşı Mh. Kızıllı Aşağı Mah. Çarşıbaşı Köyü
No:108 38073 Kurşunlu/İstanbul Tel: +90 216 517 88 85

HEATING AND COOLING CIRCULATOR UNIT

MODEL	ADA-105	HEATING CAP.	95 kW
CLIENT	TEKNOPRO A.Ş.	COOLING CAP.	55 kW
SERIAL NR.	HC201100110	TEMP. RANGE	+10 / +120 °C
ORDER NR.	P2003	M.A.W.P.	2.0 barg
YEAR	2020	INERT GAS	NITROGEN

- ISI ÜNİTESİ (SİRKÜLATÖR)
- YERLİ ÜRETİM
- Reaktör sıcaklık kontrolü
KİMYA
İLAÇ
BİYOTEKNOLOJİ

Isıtma-Sogutma Fonksiyonlu elektrikli termal sıvılı ısı ünitelerimiz ile üretim sıcaklığınız kontrol altında

US A Fabrika Otomasyon ve Mühendislik Ticaret A.Ş.
Telefon: +90 216 517 88 85 Mobile: +90 532 626 53 11
Web: www.usa-fa.com.tr Email: satis@tr-us-a.com



Referans Projelerimiz

İŞ YAPIMLARI REFERANS LİSTESİ				
FİRMA	YERLEŞKE	AÇIKLAMA	İŞ YAPIM TİPİ	SEKTÖR
BESYS-BORUSAN ENDÜSTRİYEL SİSTEMELER A.Ş.	AFYON	AFJET A.Ş. - JEOTERMAL ELEKTRİK SANTRALİ	EIC	ENERJİ
BORUSAN MAKİNE ve GÜÇ SİSTEMLERİ A.Ş.	KONYA	EREĞLİ-KOMEL DEVLET HASTANESİ TRİJEN TESİSİ	ELEKTRİK	ENERJİ
	KONYA	NEU ÜNİVERSİTE HASTANESİ TRİJEN TESİSİ	ELEKTROMEKANİK	ENERJİ
	VAN	VAN - AVM TRİJEN TESİSİ	ELEKTRİK	ENERJİ
	ANKARA	ENERJİ-SA - HİLTON TRİJEN TESİSİ	ELEKTROMEKANİK	ENERJİ
	KAYSERİ	SARIDAĞLAR MOBİLYACILAR AVM TRİJEN TESİSİ	MEKANİK	ENERJİ
	ELAZIĞ	RÖNESANS - ŞEHİR HASTANESİ TRİJEN TESİSİ	MEKANİK	ENERJİ
	İSTANBUL	MERCEDES OTOBÜS FABRİKASI TRİJEN TESİSİ	MEKANİK	ENERJİ
	ADANA	YENİ TESİS KAPASİTE ARTTIRIMI YATIRIMI	EPCM	KİMYA
AGAKİM A.Ş.	ADANA	MEVCUT ÜRETİM TESİSİ MODERNİZASYONU	EPCM	KİMYA
AKKİM A.Ş.	YALOVA	PERFORMANS KİMYASALLARI TESİSİ YATIRIMI	EIC	KİMYA
	YALOVA	HCL TESİSİ YATIRIMI	EIC	KİMYA
	YALOVA	GAZ ALGILAMA SİSTEMLERİ	EIC	KİMYA
ORGANİK KİMYA A.Ş.	İSVİÇRE	MODERNİZASYON YATIRIMI	EIC	KİMYA
DEVA HOLDİNG	AFYON	AFORIA DEVRE MÜLK ISI MERKEZİ	EIC	BİNA
MITSUBISHI ELECTRIC TÜRKİYE A.Ş.	BURSA	RÖNESANS - ŞEHİR HASTANESİ	BMS	BİNA
	İSTANBUL	RÖNESANS - İKİTELLİ ŞEHİR HASTANESİ	BMS	BİNA
LIVZYM BİOTEKNOLOJİ ARAŞTIRMA GELİŞTİRME A.Ş.	İSTANBUL	ENZİM ÜRETİM TESİSİ YATIRIMI	EPCM	BİOTEKNOLOJİ
HONEYWELL TEKNOLOJİ A.Ş.	MUĞLA	ESAN ECZACIBAŞI ENDÜSTRİYEL HAMMADDELER SAN. VE TİC. A.Ş. - FELDSPAT FLOTASYON TESİSİ	EPC	MADEN
FAYDASIÇOK HOLDİNG	İSTANBUL	GRINDBALLS ÇELİK BİLYA SAN. VE TİC. A.Ş. - ÇELİK BİLYA ÜRETİM TESİSİ SOĞUTMA SUYU SİSTEMİ	E	ÇELİK
TÜBİTAK SAGE	ANKARA	DUYARSIZ PATLAYICI ÜRETİM TESİSİ	EPCM	SAVUNMA
NİPPON BETEK BOYA	İSTANBUL	END.BAĞLAYICILAR KAPASİTE ARTTIRIMI	EPCM	KİMYA
ESAN ECZACIBAŞI MADEN SAN.AŞ	MUĞLA	YENİKÖY FELDSPAT TESİSİ MODERNİZASYON İŞLERİ	EPC	MADEN
AKCOAT	ADAPAZARI	DEĞİRMENLER AZOT-KAPAK EMNİYET SİSTEMLERİ	EPC	MADEN

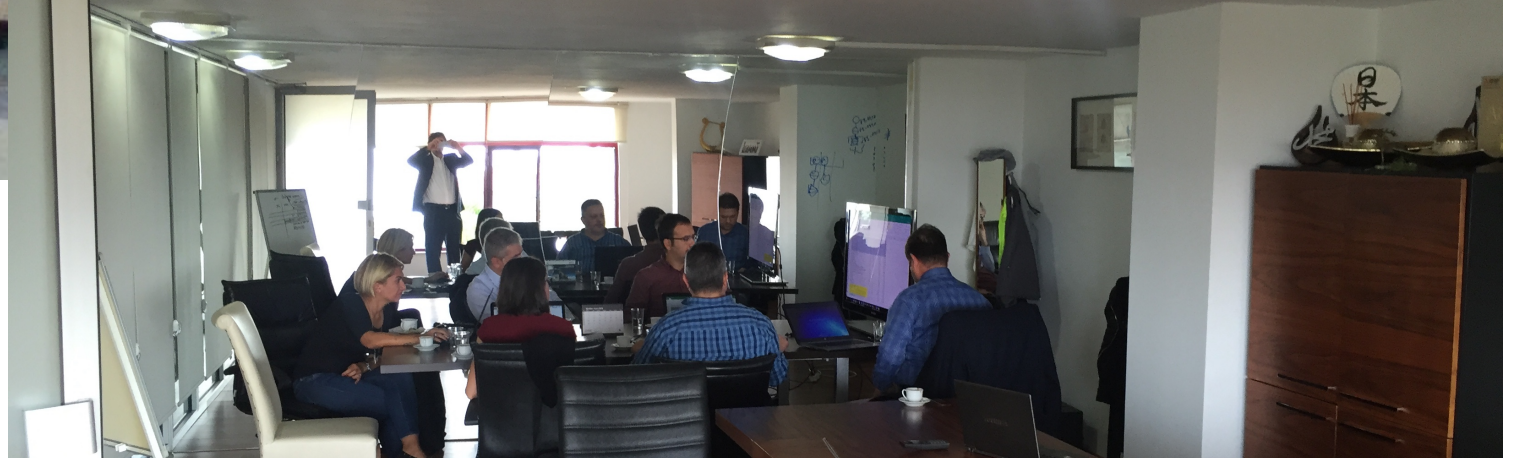

TEŞEKKÜRLER...

US A Fabrika Otomasyon ve Mühendislik Ticaret A.Ş.

Merkez : Çavuşoğlu Mh. Meşeli Ayazma Cd. Çelebi Blokları E blok No:10B 34873 Kartal/İstanbul

Yalova : Merkez Mah. Taşköprü Sanayii Sitesi 3.Yol/No:127 Taşköprü-Çiftlikköy/Yalova

Aydın : Tepecik Mah. 901 Cad. No:19(18T)-09020 Efeler/Aydın

Telefon : +90 216 517 88 85

Fax : +90 216 517 88 86

Email : satis@tr-us-a.com

Web : www.usa-fa.com